



**ERY**  
PARK AND PLAYGROUND EQUIPMENT

**KIDSTALE**  
imagination at play

**Shipped in 24 hours**

When Playtime Can't Wait

# Out the door in 24 hours

Don't delay playtime for young ones and watch as they make new friends and practice their fine motor skills. Order today and welcome tons to a range of activities and adventures in no time.

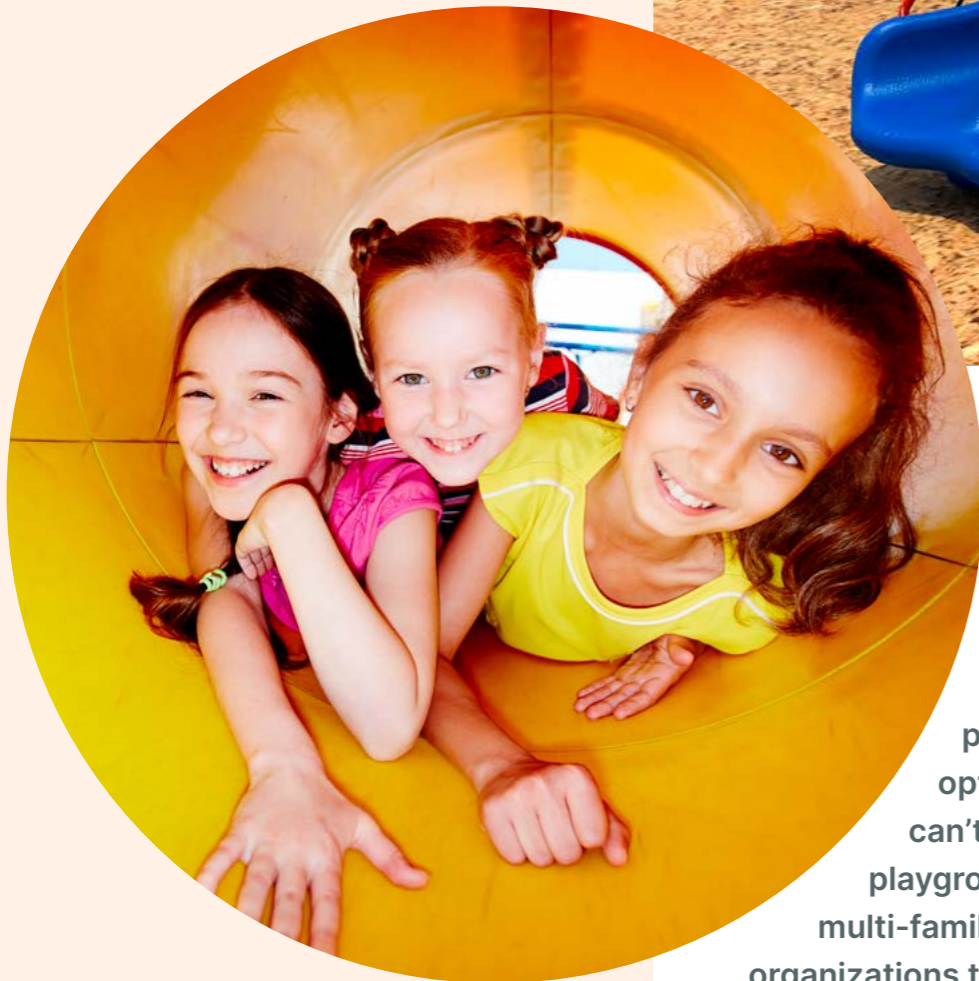

**KidsTale specializes in designing, manufacturing, and shipping quality playgrounds to fuel the imaginations of children. Our QuickShip range of playgrounds is the perfect option for when playtime can't wait. If you're looking for a playground solution to fit daycares, multi-family housing, schools, and organizations that want to improve its facilities, KidsTale won't disappoint.**

At KidsTale, we decided to maintain an extensive inventory in our new mega-warehouse which allows us to ship within 24 hours after your order has been confirmed. The QuickShip playgrounds come in a variety of sizes, so you're bound to find a model to suit your playground size without sacrificing activities. When you order a KidsTale playground you'll have peace of mind that the structure is protected against the outside elements. The steel handrails, barriers, gates, climbers, and 3.5" OD steel support posts are coated with a polyester powder coat finish for lifetime protection. The decking and stair parts

are made with 12-gage steel encased in durable PVC coating with the same high standards as the powder-coated steel parts. Plastic slides, panels, roofs, and climbers are made in rotational molds with composite resins that provide a high UV breakdown resistance ensuring the playgrounds look as good as new throughout the years. The raw materials for the HDPE (high-density polyethylene) climbers are made in our factories to ensure high-quality control and long-lasting playgrounds.



**QS-22116**

Age Group: 2-12  
 Activities: 8  
 Capacity: 20-24  
 Use Zone: 32' x 28'  
 Fall Height: 5'-0"

**Whirlwind Tower**

Kids will soon find themselves in a whirlwind of fun, excitement, and a whole lot of laughs as they make their way up and down this playground. The Whirlwind Tower offers the option to add a shade screen for playgrounds out in the open. Different slides and climbers welcome up to 24 toddlers and younger children to play together and make new friends.



**Colors**

Primary: ● ● ●  
 Natural: ● ● ●

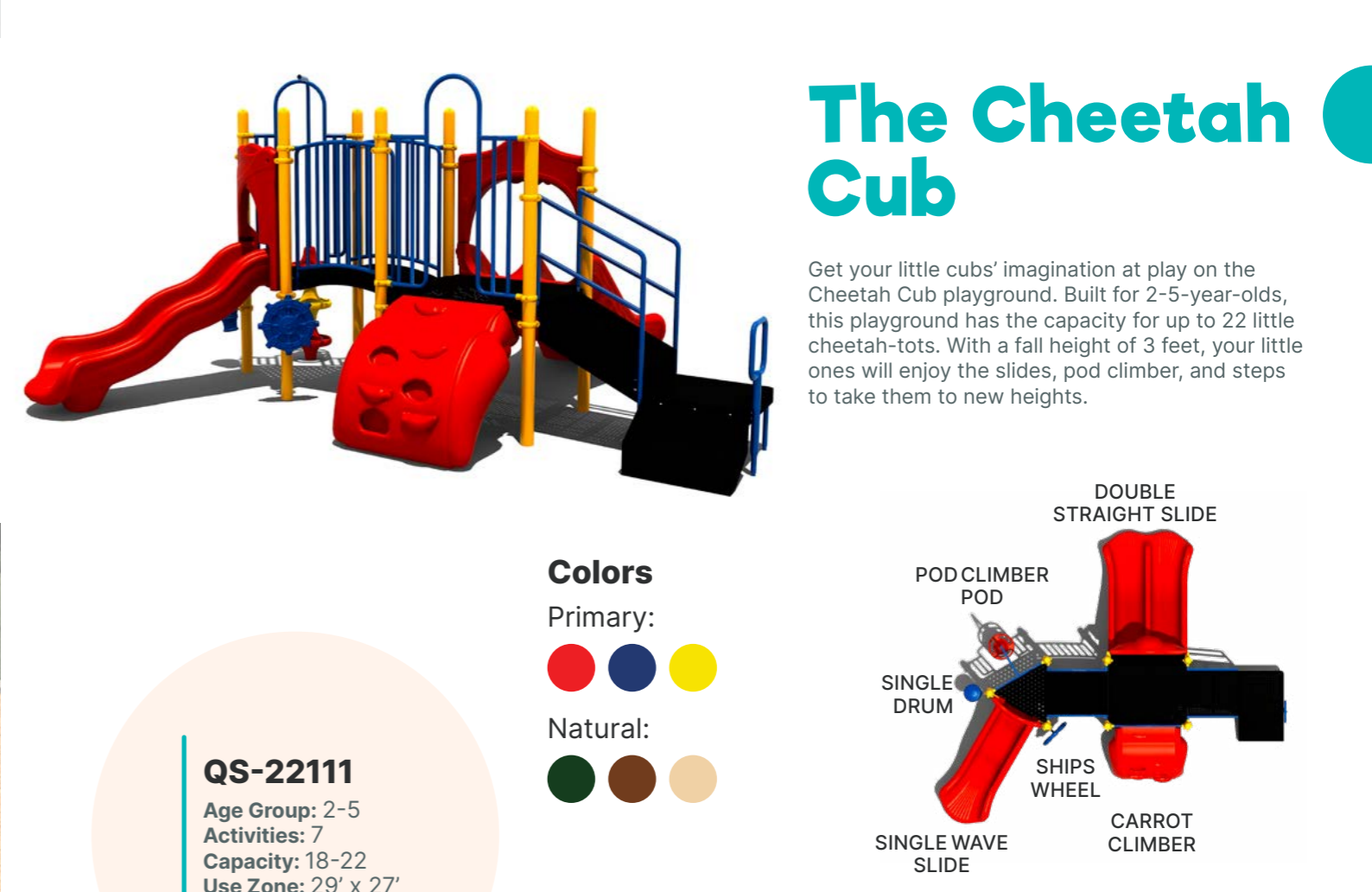
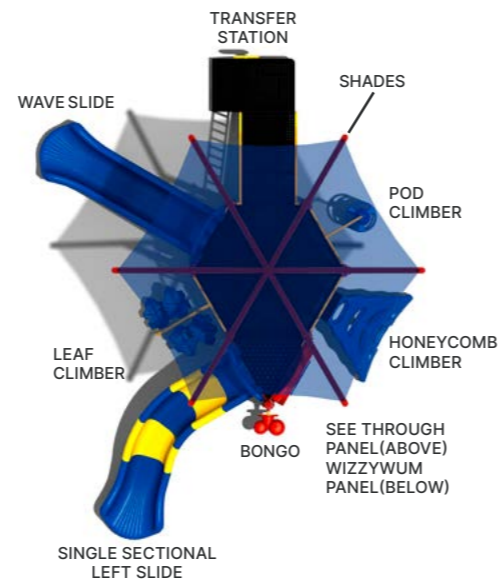

**The Cheetah Cub**

Get your little cubs' imagination at play on the Cheetah Cub playground. Built for 2-5-year-olds, this playground has the capacity for up to 22 little cheetah-tots. With a fall height of 3 feet, your little ones will enjoy the slides, pod climber, and steps to take them to new heights.

**Colors**

Primary: ● ● ●  
 Natural: ● ● ●

**QS-22111**

Age Group: 2-5  
 Activities: 7  
 Capacity: 18-22  
 Use Zone: 29' x 27'  
 Fall Height: 3'-0"

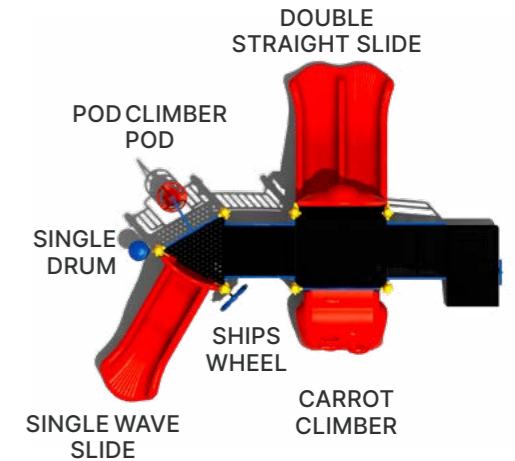



### QS-22112

Age Group: 2-5  
 Activities: 7  
 Capacity: 14-18  
 Use Zone: 29' x 24'  
 Fall Height: 3'-0"

## The Express Glider

If you're limited in space, go the express route and ramp up the fun with the Express Glider. Playtime doesn't have to wait! Seven activities in less than 600 square feet, this is a great addition to any playground with tots around. The playground features a climbing ramp, slides, and fun interactive games.

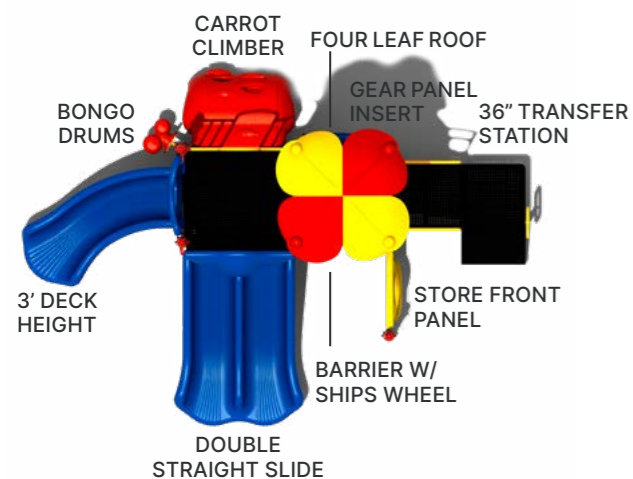

### Colors



## The Flying Alpine

Watch little ones take to the skies with The Flying Alpine playground. With 11 activities packed into 1, The Flying Alpine welcomes up to 42 children between the ages of 2 - 12 years old. Slides on different heights make it perfect for young tots and primary schoolers to play together and build confidence while learning important social skills.

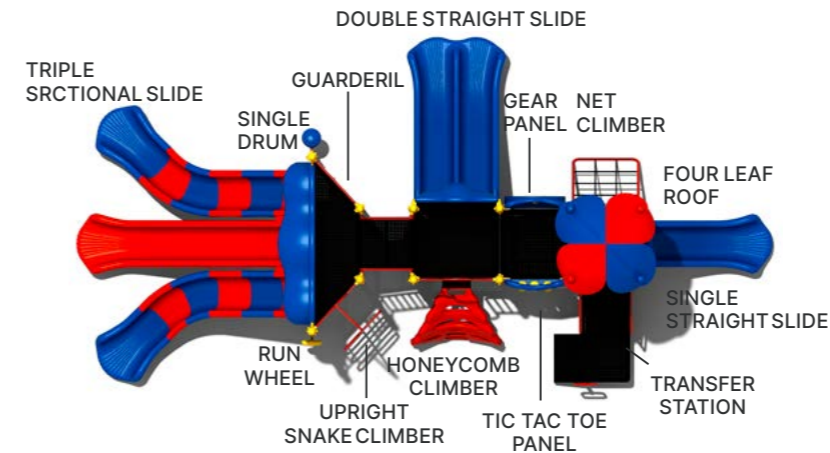

### Colors

Primary:



Natural:



### QS-22121

Age Group: 2-12  
 Activities: 11  
 Capacity: 38-42  
 Use Zone: 43' x 28'  
 Fall Height: 6'-0"





### QS-22114

Age Group: 2-12  
 Activities: 8  
 Capacity: 20-24  
 Use Zone: 20' x 24'  
 Fall Height: 4'-0"



# Clever Kids Climber

The Clever Kids Climber is bursting at the seams with a range of activities to educate. Teach your clever kids with the world clock and different climbers levels. Boost confidence and train those crucial fine motoring skills for early childhood development. Just as the name suggests, you'll soon have clever kids all over the playground.

### Colors

Primary:



Natural:

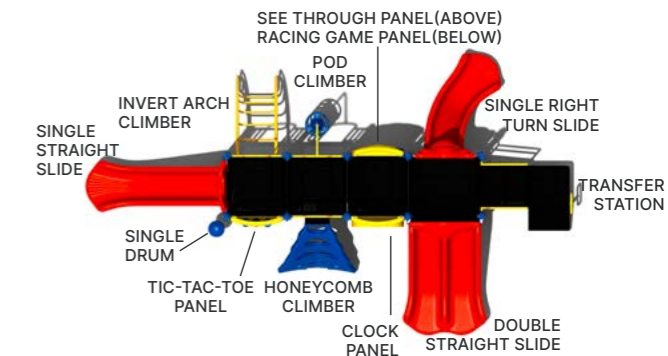

### QS-22115

Age Group: 2-12  
 Activities: 11  
 Capacity: 28-32  
 Use Zone: 37' x 27'  
 Fall Height: 4'-0"

# Turboville Titan

Next stop, Turboville! Get little ones into turbo gear and watch them play to their hearts' content. The Turboville Titan playground connects two decks with a tunnel to provide more activities alongside fun interactions. Two slides on each side curve on the sides to keep tots safe while railing helps them explore with confidence.

### Colors

Primary:



Natural:

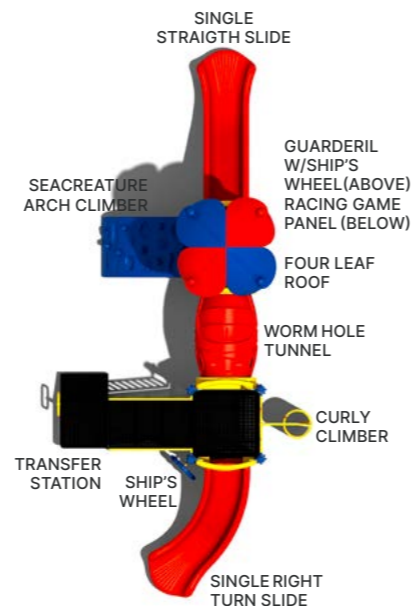



**QS-22118**

Age Group: 2-12  
 Activities: 8  
 Capacity: 16-20  
 Use Zone: 32' x 31'  
 Fall Height: 5'-0"

# Child Centers

Discover the joy of playing with KidsTale Child Centers - a realm where young imaginations thrive. A fun, safe, and cost-effective playground for toddlers and preschoolers. Our Child Centers are designed to captivate hearts and energize spirits. Accommodating up to 20 kids, these centers are safe havens, featuring sturdy railings and diverse play panels, from the Fish Climber to the Tic Tac Toe Panel.

Each piece is crafted to encourage exploration and adventure, ensuring every moment is filled with laughter and learning. These delightful play areas are ready to ship within 24 hours of order confirmation, bringing rapid joy to any community.

## Sunnyside Lodge

**CD-03X**

Age Group: 2-5  
 Capacity: 14  
 Use Zone: 21'-5" x 21'-2"  
 Fall Height: 3'-3"

**Color as shown**

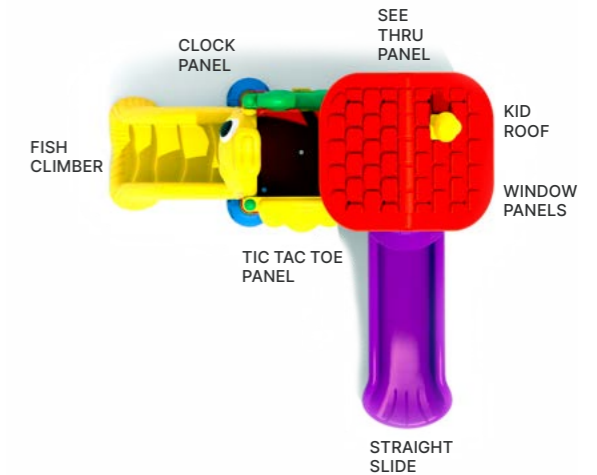

## Slidesburg USA

Keep an eye on the kiddos as their hearts fill with joy as they slide and climb their way up and down the Slidesburg USA playground with enough space for up to 20 kids. The railings keep children safe as they make their way from the climbers to the slides ready to explore everything that playtime has to offer.

**Colors**

Primary:



Natural:

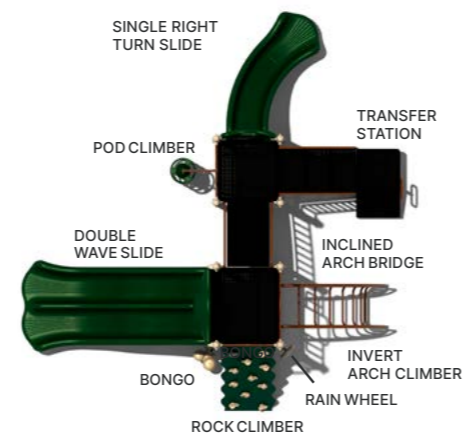

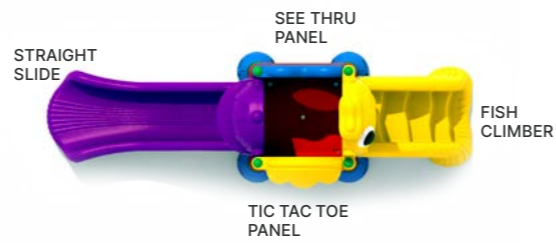

## The Octopod

**CD-02**

Age Group: 2-5  
Capacity: 10  
Use Zone: 24'-4" x 15'-3"  
Fall Height: 2'-7"

**Color as shown**

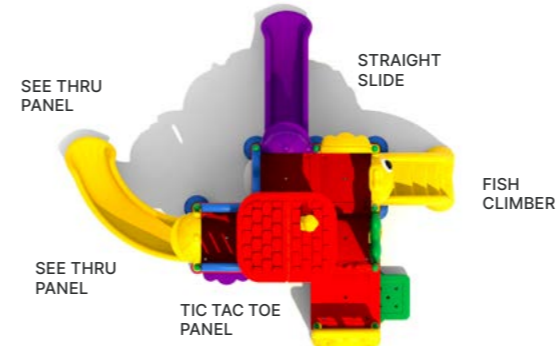

## The Willowby Woosh

**CD-05**

Age Group: 2-5  
Capacity: 29  
Use Zone: 30'-3" x 27'-6"  
Fall Height: 4'-0"

**Color as shown**



## Magic Motor

**CD-04**

Age Group: 2-5  
Capacity: 20  
Use Zone: 27' x 21'  
Fall Height: 3'-3"

**Color as shown**

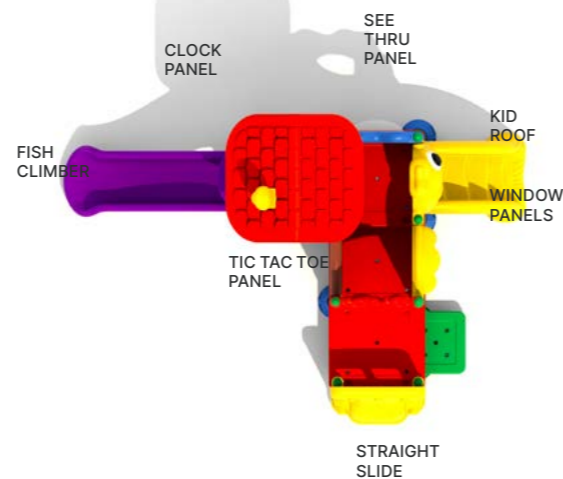

## Rainbow Cottage

**CD-06**

Age Group: 2-5  
Capacity: 35  
Use Zone: 32'-10" x 31'-6"  
Fall Height: 4'-0"

**Color as shown**

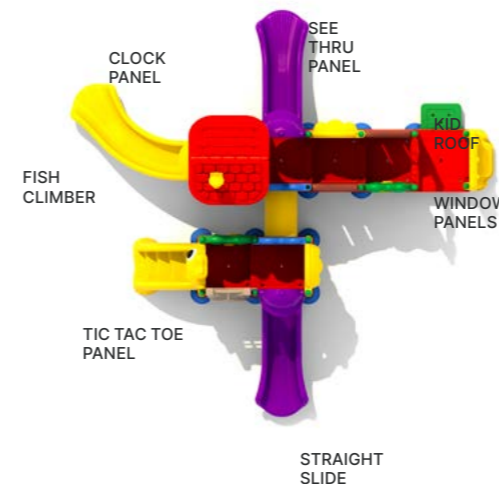

# Swings

**Color:**  
All Swings are available in Blue, Brown, Rainforest Green, and Red.



**ASF-350802** | Blue

Description	Part Number	Use Zone
3.5" Arch Swing Frame 8ft - 1 Bay	ASF-350801	23'-9"x32'-0"
3.5" Arch Swing Frame 8ft - 2 Bay	ASF-350802	35'-1"x32'-0"
3.5" Arch Swing Frame 8ft - 3 Bay	ASF-350803	46'-5"x32'-0"
3.5" Arch Swing Frame 8ft - 4 Bay	ASF-350804	57'-8"x32'-0"

Description	Part Number	Use Zone
5" Arch Swing Frame 8ft - 1 Bay	ASF-500801	23'-7"x32'-0"
5" Arch Swing Frame 8ft - 2 Bay	ASF-500802	35'-3"x32'-0"
5" Arch Swing Frame 8ft - 3 Bay	ASF-500803	46'-8"x32'-0"
5" Arch Swing Frame 8ft - 4 Bay	ASF-500804	58'-0"x32'-0"

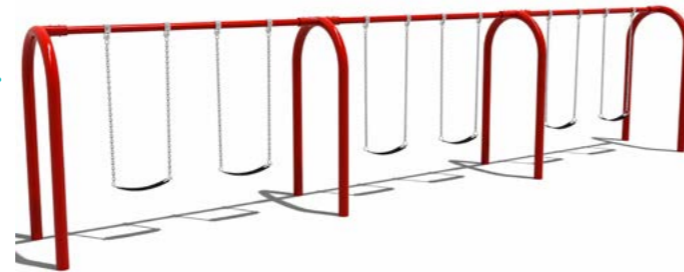

**ASF-500803** | Red



**SPF-0801** | Rainforest Green

Description	Item Number	Use Zone
5" Single Post Swing Frame 8ft - 1 Bay	SPF-0801	23'-9"x32'-0"
5" Single Post Swing Frame 8ft - 2 Bay	SPF-0802	35'-3"x32'-0"
5" Single Post Swing Frame 8ft - 3 Bay	SPF-0803	46'-8"x32'-0"
5" Single Post Swing Frame 8ft - 4 Bay	SPF-0804	58'-0"x32'-0"

## SPF-80266

**Description:** 5" Single Post Swing with Arm  
**Item Number:** SPF-80266  
**Use Zone:** 29'-11"x32'-0"



**SPF-80266** | Brown

# Freestanding

Primary



Natural



## Maze Go Round

### FS-1810

**Age Group:** 2-12  
**Capacity:** 4-8  
**Use Zone:** 23'-3" x 23'-3"  
**Fall Height:** 1'-0"

## Ball Spinner

### FS-1604

**Age Group:** 2-12  
**Use Zone:** 15'-5" x 15'-3"  
**Fall Height:** 1'-8"



Natural

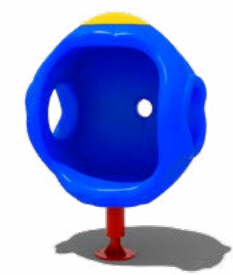

Primary



Primary



Natural

## Rocket Spinner

### FS-1803

**Age Group:** 5-12  
**Use Zone:** 13'-1" x 13'-1"  
**Fall Height:** 1'-0"



Brown



Primary



Natural

## Two Seat Seesaw - Two Springs

### SR-1404

**Age Group:** 2-12  
**Capacity:** 2  
**Use Zone:** 18'-11" x 13'-9"  
**Fall Height:** 2'-0"



# Freestanding

# Freestanding



**Farm Truck Spring Rider**

**SR-2004**

Age Group: 2-12  
Capacity: 1  
Use Zone: 14'-9" x 12'-11"  
Fall Height: 2'-0"



**Tractor Spring Rider**

**SR-2015**

Age Group: 2-12  
Capacity: 1  
Use Zone: 14'-10" x 13'-3"  
Fall Height: 1'-6"



**Bumble Betsy Spring Rider**

**SR-1604**

Age Group: 2-12  
Capacity: 2  
Use Zone: 16'-6" x 14'-0"  
Fall Height: 2'-0"



**Frog Spring Rider**

**SR-2005**

Age Group: 2-12  
Capacity: 1  
Use Zone: 14'-9" x 13'-4"  
Fall Height: 2'-0"



**Bulldozer Spring Rider**

**SR-2003**

Age Group: 2-12  
Capacity: 1  
Use Zone: 14'-9" x 12'-3"  
Fall Height: 2'-0"



**Carmen Croc Rider**

**SR-2226**

Age Group: 2-5  
Capacity: 2  
Use Zone: 17'-0" x 13'-5"  
Fall Height: 1'-8"



**Wally Raptor Rider**

**SR-2227**

Age Group: 2-5  
Capacity: 2  
Use Zone: 17'-5" x 13'-11"  
Fall Height: 1'-9"

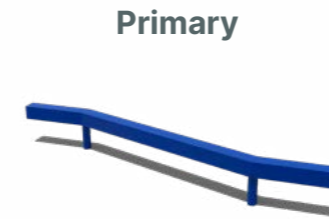

Primary

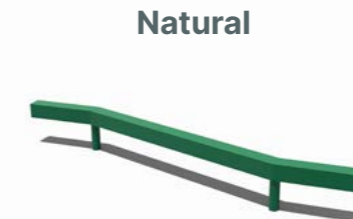

Natural

**Parallel Bars**

**FS-80254**

Age Group: 5-12  
Capacity: 2-3  
Use Zone: 19'-3" x 14'-0"  
Fall Height: 3'-4"



Natural



Primary



Blue



Green



Red

**32 Gallon Trash Receptacle w/Lid and Liner**

**PAC-28607**

Age Group: 2-12

**6' Bench with Back - Perforated**

**PAC-28604**

Age Group: 2-12  
Capacity: 3



Blue

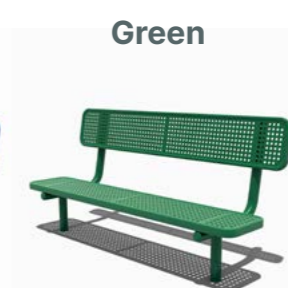

Green



Red

# Pocket Parks

Introducing KidsTale Pocket Parks - your solution for compact, yet comprehensive, play areas. Ingeniously designed to maximize fun in minimal spaces, our Pocket Parks embody the essence of play in a neat package.

Perfect for urban settings or small communities, these parks are a testament to our innovative approach. With the QuickShip promise, the entire pocket park, tailored to your needs, is ready for dispatch within 24 hours of post-order confirmation. Transform underutilized spaces into vibrant hubs of activity and joy with KidsTale Pocket Parks.

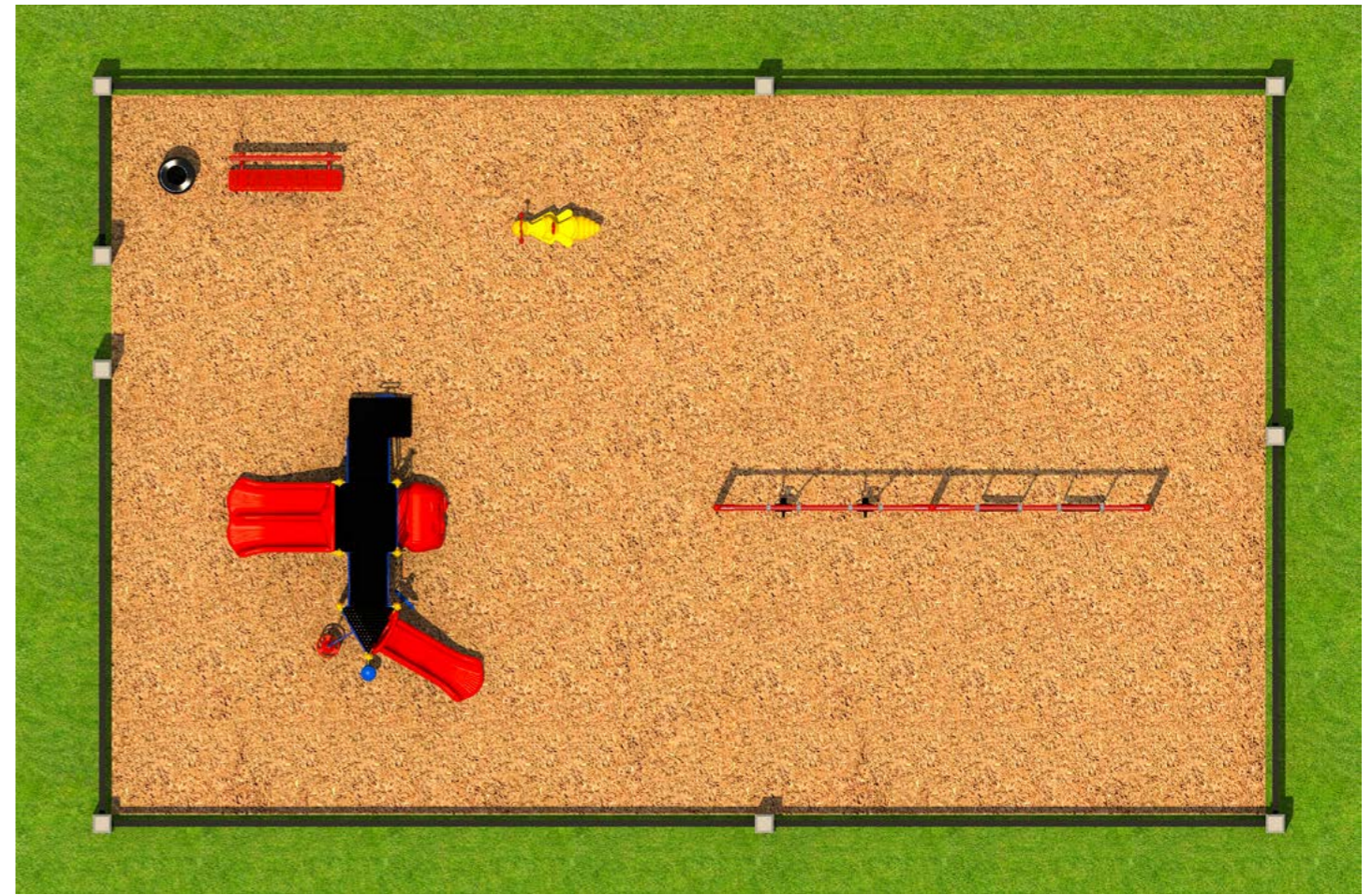

## QS-PP2313

Age Group: 2-5  
 Activities: N/A  
 Capacity: 24-28  
 Use Zone: 61' x 38'  
 Fall Height: 7'-6"

## The Cheetah Cub Pocket Park

A vibrant play destination for the youngest explorers, The Cheetah Cub Pocket Park caters to children aged 2-5. Packed with interactive elements, it's designed to stimulate early development through playful learning, and it fits up to 22 little cheetah-tots. The park's compact size does not compromise on fun, offering a variety of activities that foster physical and cognitive skills. This entire playful paradise is ready for dispatch within 24 hours of order confirmation, ensuring no delay in delivering joy and adventure.

### Colors

Primary:



Natural:



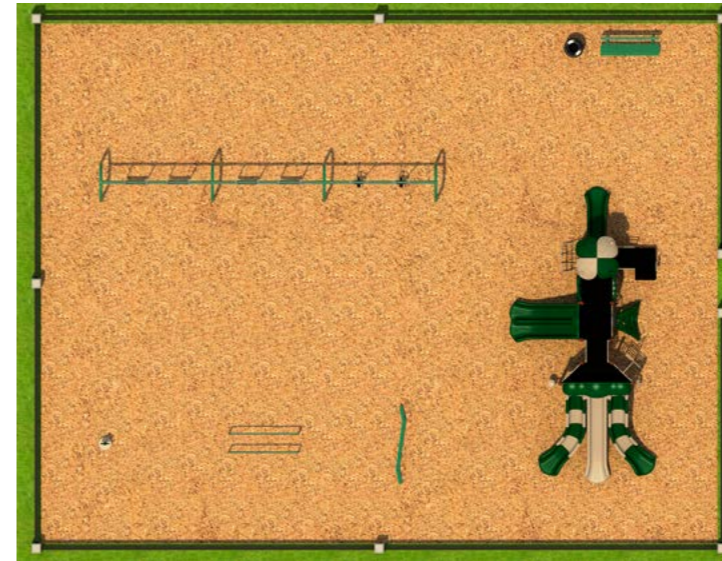

## The Flying Alpine Pocket Park

Designed for children aged 5-12, The Flying Alpine Pocket Park is a hub of energetic activity and creative play. With diverse play elements, it caters to a wide age range, ensuring inclusivity and versatility. Welcomes up to 42 children.

This park blends physical challenges with imaginative scenarios, offering a safe yet thrilling environment for kids to explore. Slides on different heights make it perfect for young tots and primary schoolers to play together and build confidence while learning important social skills. The entire park is ready for shipping within 24 hours of order confirmation, guaranteeing a swift transition from planning to play.

### QS-PP2330

Age Group: 5-12  
 Activities: N/A  
 Capacity: 50-54  
 Use Zone: 69' x 53'  
 Fall Height: 7'-6"

### Colors

Primary:



Natural:



**QS-PP2321**

Age Group: 2-12  
Activities: N/A  
Capacity: 26-30  
Use Zone: 59' x 47'  
Fall Height: 7'-6"

## The Whirlwind Tower Pocket Park

The Whirlwind Tower Pocket Park is a dynamic space where children aged 2-12 can engage in endless adventures. This park encourages active play, social interaction, and imaginative exploration.

From climbers to slides, it's a world where every turn brings a new discovery. Offering the option to add a shade screen for playgrounds out in the open and fitting up to 24 youngsters. This playground is designed for quick installation, the entire set is prepared for dispatch within 24 hours of order confirmation, making it an ideal choice for communities seeking immediate play solutions.

### Colors

Primary:



Natural:

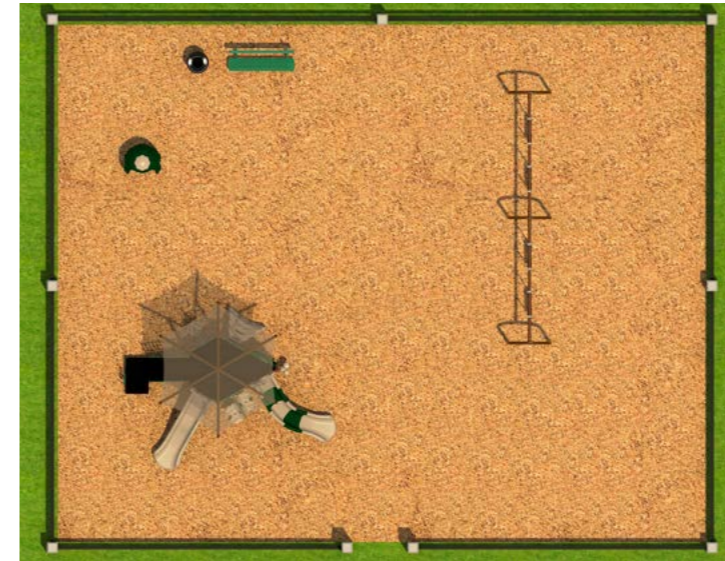



[kidstaleplaygrounds.com](http://kidstaleplaygrounds.com)

Visit our website to place your order or get in touch with our helpful team to guide you with any questions you may have.

**Fry & Associates, Inc.**  
[www.fryparks.com](http://www.fryparks.com)  
[fun@fryinc.com](mailto:fun@fryinc.com)

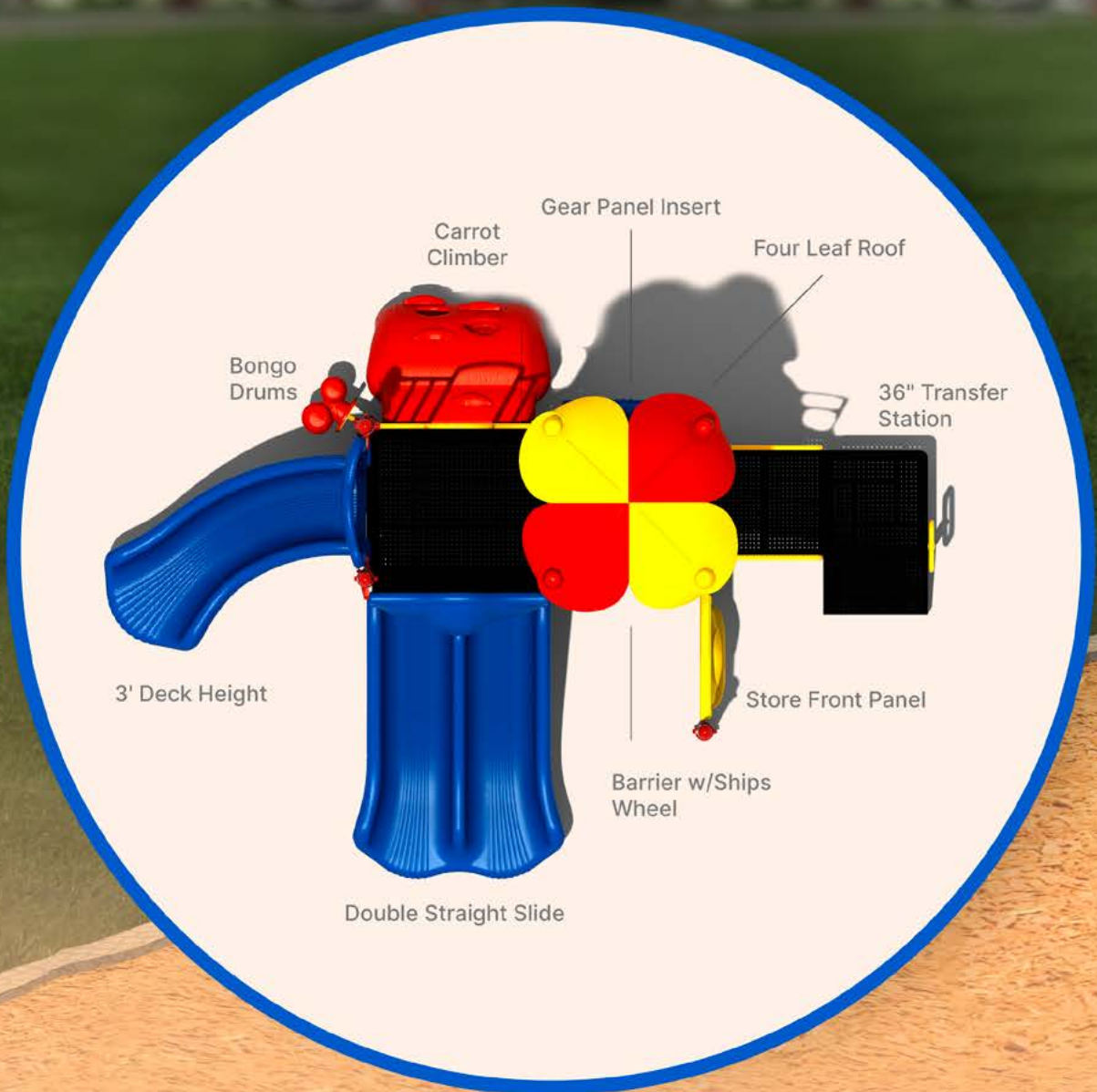

11945 North Freeway, Ste 200  
Houston, TX 77060 U.S.A.



[sales@kidstaleplaygrounds.com](mailto:sales@kidstaleplaygrounds.com)  
1+(844) 543-7825